

Wetguard 15 Amp. 2-Pole 3-Wire

ELECTRICAL	
DIELECTRIC VOLTAGE	CURRENT INTERR.
Withstands 2000V per UL 498	Full rated current
TEMP. RISE	
Max 30°C after 250 cycles of overload at 200% of rated current	

MECHANICAL						
TERMINAL I.D.	PRODUCT I.D.	DEVICE TYPE			CORD GRIP RANGE	
Brass, hot	Ratings & NEMA I.D. permanently marked on device	15 & 20A Straight Blade & 15A Locking - 3-Wire			(.375" - .655") #18-#10 AWG	
Grounding		20A Locking 3-, 4- & 5-Wire			(.375" - .875") #18-#10 AWG	
White, neutral		30A Locking 3-, 4- & 5-Wire			(.625" - 1.125") #12-#8 AWG	
ENVIRONMENTAL				STANDARDS & CERTIFICATIONS		
FLAMMABILITY		OPERATING TEMP.		NEMA WD-6	ANSI C-73	UL 498
Plugs & Connectors Rated V-2 per UL 94	Receptacles Rated V-0 per UL 94	-40°C to 60°C		✓	✓	✓
				UL Fed Spec Listed WC-596		CSA C22.2 No.42
				Plugs & Connectors #E13393		Receptacles #E13399
						#LR-406
						#057

Wetguard Products
 Are Engineered to Meet or Exceed UL and IEC Watertight Standards

Plugs & Connectors
 mated or with closure caps meet IP66 & IP67 Standards



14W47



14W47-B



15W47



15W47-B

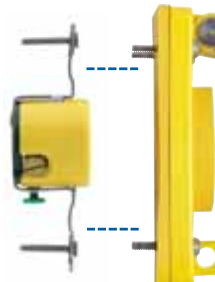

60W47

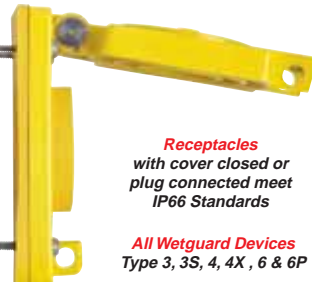

















Receptacles
 with cover closed or plug connected meet IP66 Standards

All Wetguard Devices
 Type 3, 3S, 4, 4X, 6 & 6P



47CM-10

TYPE-EPTR	PLUG	NEMA PLUG	CONNECTOR w/ CLOSURE CAP	CORROSION RESISTANT RECEPTACLE, COVER, GASKET	CORROSION RESISTANT RECEPTACLE	NEMA RECEPTACLE
15A 125V, 2-P 3-W, Grounding						
Yellow Rubber	14W47	 5-15P	15W47	60W47	5261-CR	 5-15R
Black Rubber	14W47-B		15W47-B	See Below for Black Catalog No.	-	
15A 250V, 2-P 3-W, Grounding						
Yellow Rubber	14W49	 6-15P	15W49	60W49	5661-CR	 6-15R
15A 277V, 2-P 3-W, Grounding						
Yellow Rubber	14W34	 7-15P	15W34	-	-	 7-15R
15A 125V, 2-P 3-W, Grounding						
Yellow Rubber	24W47	 L5-15P	25W47	65W47	47CM-10	 L5-15R
15A 250V, 2-P 3-W, Grounding						
Yellow Rubber	24W49	 L6-15P	25W49	65W49	45CM-60	 L6-15R
15A 277V, 2-P 3-W, Grounding						
Yellow Rubber	24W34	 L7-15P	25W34	65W34	47CM-60	 L7-15R

CONNECTOR CAPS For Black Caps, Add Suffix -B	PLUG CAPS For Black Caps, Add Suffix -B	COVER w/ GASKET For Black Covers, Add Suffix -B	BLANK PLATE w/ GASKET	FD BOX GLASS-FILLED POLYESTER (2 KO Openings)
 Yellow 15/20A Str. Blade & 15A Locking 50W50 20A Locking 50W52 30A Locking 50W54	 Yellow 15/20A Str. Blade & 15A Locking 14W 20A Locking 26W 30A Locking 28W	 Yellow 15/20A Str. Blade & 15A Locking 60W03 20A Locking 60W04 30A Locking 60W05	 Yellow WP459	 Yellow 1/2" 452CR 3/4" 453CR 1" 454CR

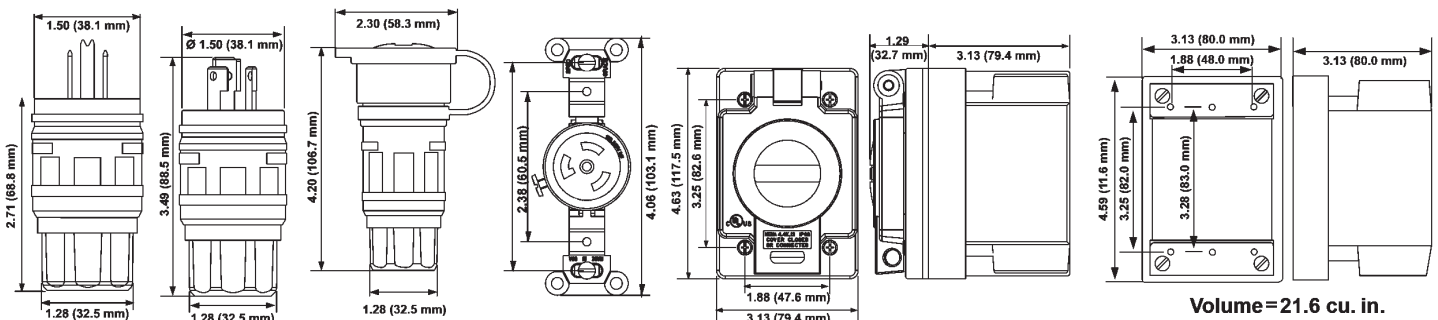

PLUGS, CONNECTORS & RECEPTACLES

FD BOX & COVER

FD BOX

Volume = 21.6 cu. in.